



SÜPÜRĞELİK

akdeio

Forest Products Ground Materials Import Export Marketing Industry and Trade
LIMITED COMPANY

Mobile Company: +90 532 250 65 29

Phone: +90 212 111 11 11

Address: Atakent Mah. 243. Sk. No:6 Tema İstanbul Sitesi 7/B No:1 Halkalı / Çekirgece İstanbul / TÜRKİYE



akdeio[®]
forest products ground materials
import export
marketing industry and trade
LIMITED COMPANY

www.akdeio.com.tr
info@akdeio.com.tr

[akdeio](#)
[akdeioorman](#)

SÜPÜRGELİK PROFİLLERİ

SKIRTING PROFILES

Yeni
New

SPR-8102

12x78x2800 mm

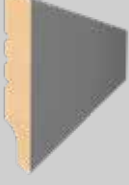

Yeni
New

SPR-8100

12x96x2800 mm



Yeni
New

SPR-8103

12x96x2800 mm



Yeni
New

SPR-8105

9x101x2800 mm

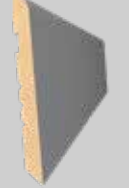

SPR-9011

12x100x2800 mm



SPR-9010

12x80x2800 mm



SPR-9007

12x80x2800 mm



SPR-9028

12x80x2800 mm



SPR-9029

12x100x2800 mm



SPR-6050

12x22x2800 mm



SPR-5030

9x60x2800 mm



SPR-5000-E

9x79x2800 mm



SPR-7034

9x80x2800 mm



SPR-7063

9x80x2800 mm



SPR-7007

16x80x2800 mm



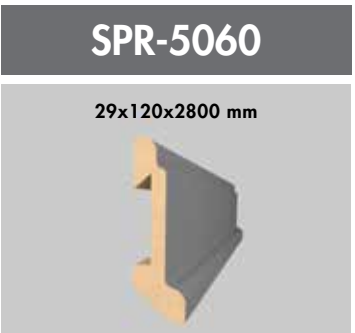
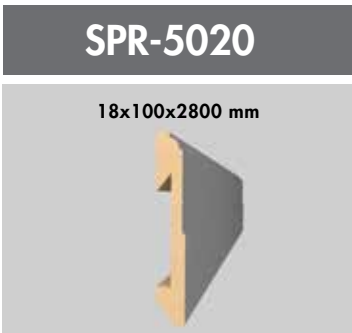
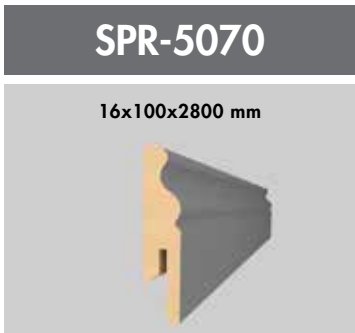
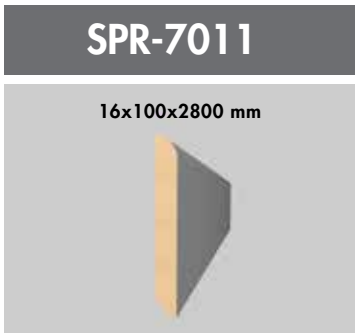
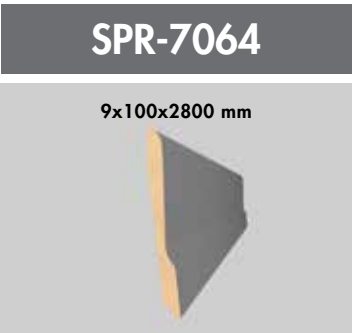
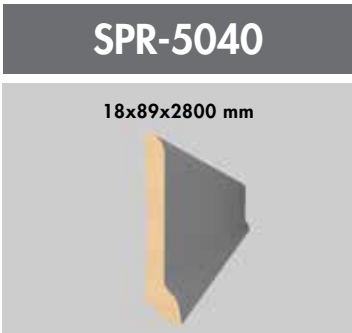
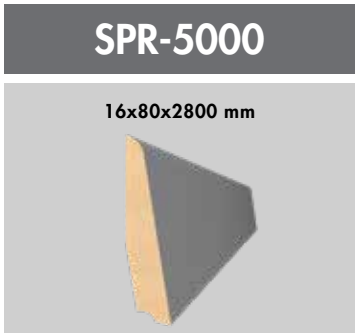
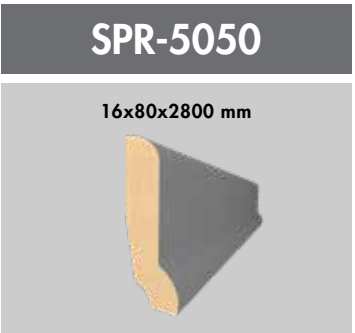
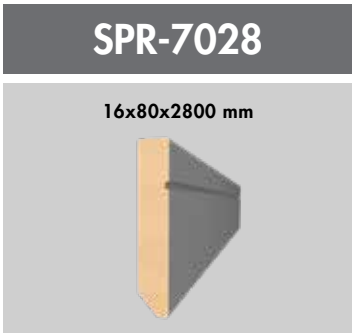
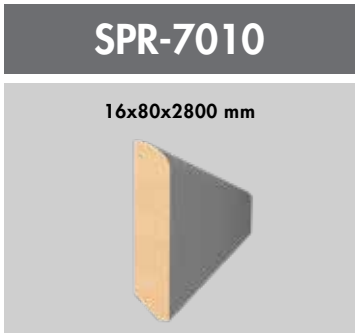

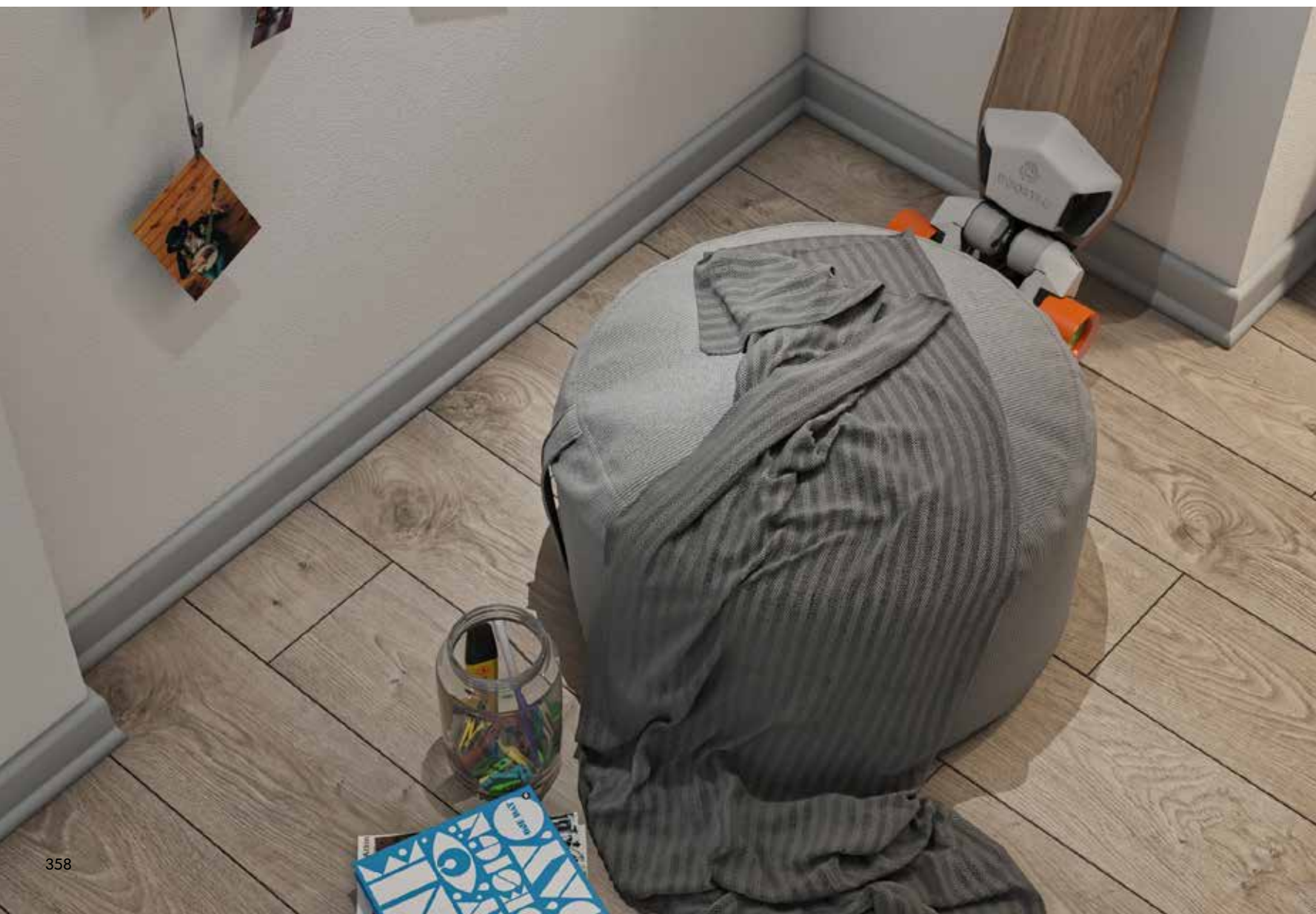

SÜPÜRGELİK DEKORLAR

SKIRTING DECORS

Beyaz (Boyanabilir) / White (Paintable)



231 Bute Beyaz/
Plain White

1.Grup / 1.Group



3072 Lake Beyaz/
Lacquer White



3067 Lake Gri/
Lacquer Grey



3068 Lake Antrasit/
Lacquer Anthracite

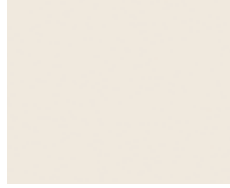

366 Bianco



369 Alman Meşe/
German Oak



248 Tik/Teak

2.Grup / 2.Group

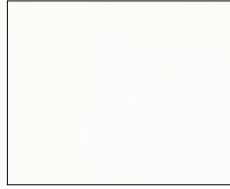

734 Soft Touch
Beyaz/Soft Touch
White

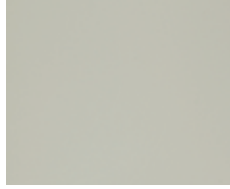

729 Soft Touch
Yeni Gri/Soft Touch
New Grey



728 Soft Touch
Kaya Gri/Soft
Touch Stone Grey



726 Soft Touch
Fırtına Gri/
Soft Touch Storm
Grey





723 Soft Touch
Siyah/Soft Touch
Black



608 HG Metalik
Antrasit/HG Metallic
Anthracite

AGT SÜPÜRGELİK KARKAS MODELLERİ

AGT SKIRTING CARCASS MODELS

KOD NUMARASI/ CODE NUMBER	ÖLÇÜ (mm)/ MEASUREMENT (mm)	ÜRÜN KESİTİ/ CROSS-SECTION	UYUMLU SÜPÜRGELİKLER/ AVAILABLE SKIRTINGS
SK-2001	10x43x2800		SPR-5070
SK-2000	10x51x2800		SPR-5020 / SPR-5060

